

LV-BST-L5.12Aa Operation Manual

This Manual introduces LV-BST-L5.12Aa from Lithiumvalley. LV-BST-L5.12Aa is a 51.2V DC Lithium-ion Phosphate Battery storage system. Please read this manual before you install the battery and follow the instruction carefully during the installation process. Any confusion, please contact Lithiumvalley immediately for advice and clarification.

Catalogue

1 Safety Information	
1.1 General Safety.....	2
1.2 Personal Safety.....	2
1.3 Electrical Safety.....	3
1.4 Transportation Safety.....	3
2 System Information	
2.1 Product introduction.....	4
2.2 Specification.....	4
2.2.1 Battery Module.....	4
2.2.2 LED Indicator Definition.....	6
3 Installation.....	6
3.1 Tool.....	6
3.2 Checking deliverables.....	6
3.3 Installation requirement.....	6
3.4 Installation.....	7
4 Maintenance	11



1 Safety Information

1.1 General Safety

Please carefully read the manual safety precautions and observe all the safety instructions on the equipment and in this document.

The "DANGER", "WARNING", and "NOTICE" statements in this document do not cover all the safety instructions. They are only supplements to the safety instructions.

For user safety and utilization efficiency of this manual, a list of symbols is designed to alert people from danger. You must understand and comply with the emphasized information to avoid personal injury and property damage. Relative safety symbols have been listed below.

 Danger	DANGER indicates a hazardous situation which, if not avoided will result in serious injury and fire.
 Danger	WARNING indicates a hazardous situation which, if not avoided will result in property loss or void warranty.
 Notice	NOTICE indicates normal situation which, if not avoided will result in that battery doesn't work.

Notice

Follow local laws and regulations when installing, operating, or maintaining the equipment. The safety instructions in this document are only supplements to local laws and regulations.

1.2 Personal Safety

Personal Requirements

People who plan to install or maintain battery equipment must be trained, understood all necessary safety precautions, and are able to perform all operations correctly.

Only qualified professionals or trained people are allowed to install, operate, and maintain the equipment.

Personal Safety







Danger

- Do not place battery at a children or pet touchable area.
- Do not touch the energized battery, as the enclosure is hot.
- Do not touch the energized battery terminals.
- Do not stand on, lean on, or sit on the battery.

1.3 Electrical Safety

Symbols on Battery

There are some electrical symbols on battery relate to electrical safety. Please make sure you have fully understood them before installation.

	Electrical danger	Voltage exists when the battery is powered on. Only qualified engineers are allowed to operate.
	Earth connector	Earth connection.
	DC positive and negative connectors	Identify positive and negative connectors of DC power source.
	CE mark	The product meets CE certification.
	WEEEtag	Can't leave battery as garbage disposal.
	Recycle	Battery can be recycled.

Electrical Safety

Danger

- Before installation, ensure that the equipment is intact. Otherwise, electric shocks or fire may occur.
- Do not connect or disconnect power cables when battery is power-on. Which may cause electric arcs and sparks more over fire or personal injury. Before connecting a power cable, check the positive or negative connectors are correct.
- Do not parallel connection with different batteries.
- Do not connect battery with AC directly.
- Do not connect battery with PV wiring directly.
- Do not connect batteries in series.
- Do not connect battery to faulty or unqualified inverter or charger.
- Do not create short circuits with the external connection.
- Make sure the grid is cut off and the battery is powered off before maintenance.
- Make sure the earth cable is connected correctly before operation.

Warning

- Recharge battery in every six months.
- Recharge battery within 10 days after battery is fully discharged.
- Make sure battery cable placement is installed correctly.
- When the battery is being installed or repaired, make sure the battery is powered off and using a multi meter to make sure there is no voltage in the positive and negative terminals.

Notice

- Please use dedicated insulated tools for install and maintenance.
- Please make sure all batteries are power-off when multiple parallel connection.
- Please check lights on sequence when battery power-on.
- Please make sure communication connection connect correctly with battery and inverter.
- Please check inverter alarm or SOC reading when there is BMS communicated with inverter.

Environment Safety

Warning

- Ensure that the equipment is installed in a dry and well-ventilated environment.
- The installation position must be away from direct sunlight and rain.
- The installation position must be far away from fire sources.
- The installation position must be far away from water sources such as taps, sewer pipes, and sprinklers to prevent water seepage.
- Do not expose the equipment to flammable or explosive gas or smoke.
- Do not perform any operation on the equipment in such environments.
- The operation and service life of the battery depends on the operating temperature. Operate the battery at a temperature equal to or better than the ambient temperature. The recommended operating temperature range is from 0°C to 30°C.

1.4 Transportation Safety

Warning

- The products passed certification UN38.3.
- The products have MSDS.
- The products belong to class 9 dangerous goods.
- Please protect the packing case from the below situations.
- Being dampened by rains, snows, or falling into water.
- Falling or mechanical impact.
- Being upside-down or tilted.

2 System Information

2 System Information

2.1 Product introduce

LV-BST-L5.12Aa is a 51.2V DC battery storage system based on lithium-iron phosphate battery, which is one of the new energy storage products developed and produced by Lithiumvalley. It can be used to support reliable power for various types of equipment and systems. LV-BST-L5.12Aa is especially suitable for those application scenes which required high power output, limited installation space, restricted load-bearing and long cycle life.

2.2 Specification

2.2.1 Battery Module

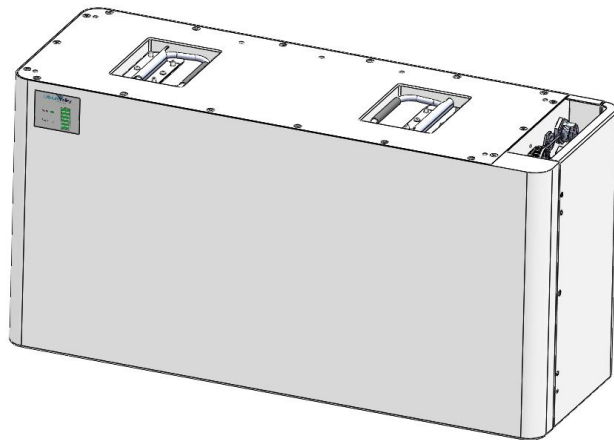

Cable Panel

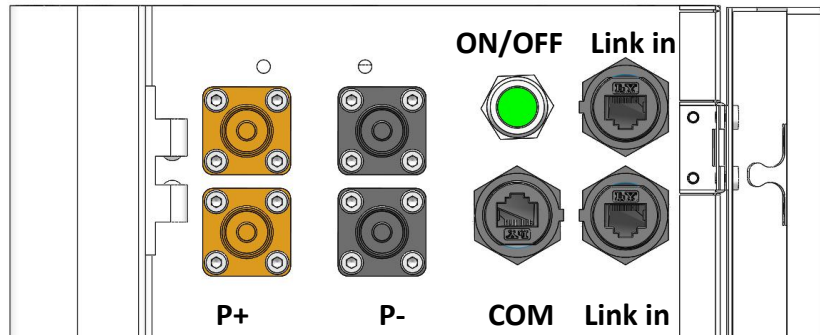

ON/OFF

1. ON

For single Battery Module, Long press (more than 3 seconds) ON/OFF button, Normal LED will be lighted in the front panel then battery will operate normally. L1 to L6 shows battery SOC, L7/L8 shows battery status.

For multiple Battery Modules in parallel, long press (more than 3 seconds) ON/OFF button of MASTER battery (Which connect with inverter), normal LED will be lighted, battery system will automatically encode and assign ID to each slave battery, then battery system will operate normally.

2 OFF

Press ON/OFF button of Master PACK (which connect with inverter) more than 3s, LED will flash in the front panel and then release the button, the master pack will shut down after all slave packs shut down (Sleep mode).

For single Battery Module, Long press (more than 3 seconds) ON/OFF button, LED will flash in the front panel and then release the button, the battery will shut down.

In the system with inverter, there is an air switch between inverter and battery system, normally the air switch keeps off-state if the system does not work.

COM Port

CAN / RS485/RS232 Communication Terminal (RJ45 port),

CAN/RS485 connect to inverter, follow CAN / RS485 protocol.

RS232 Communication follow RS232 protocol, for manufacturer or professional engineer to debug or service.

PIN	Definition
Pin 1	RS485-B (to PCS, reserved)
Pin 2	RS485-A (to PCS, reserved)
Pin 3	GND_2
Pin 4	CANH (to PCS)
Pin 5	CANL (to PCS)
Pin 6	RS232_TX
Pin 7	RS232_RX
Pin 8	RS232_GND

Link in/Link out

Link in/Link out are used for the communication between battery piles. The battery pack close to the inverter as the master, others are the slave pack.

2.2.2 LED Indicator Definition



flash 1 - 0.25s light//3.75s off flash
 2 - 0.5s light / 0.5s off flash 3 - 0.5s
 light / 1.5s off

LED Indicators Instructions

Status	Normal	Fault	Battery Level Indicator							Descriptions
	L8	L7	L6	L5	L4	L3	L2	L1		
Shut-down	OFF	OFF	OFF	OFF	OFF	OFF	OFF	OFF	OFF	All OFF
Standby	Flash 1	OFF	According to the battery level							Indicates Standby
Charging	Normal	Light	According to the battery level							The highest capacity indicator LED flashes(flash 2),others lighting
	Full Charged	Light	OFF	Light	Light	Light	Light	Light	Light	Turn to standby status when charger off
	Protection	OFF	Light	OFF	OFF	OFF	OFF	OFF	OFF	Stop charging
Discharge	Normal	Flash 3	According to the battery level							
	UVP	OFF	OFF	OFF	OFF	OFF	OFF	OFF	OFF	Stop charging
	Protection	OFF	Light	OFF	OFF	OFF	OFF	OFF	OFF	Stop discharge
	Fault	OFF	Light	OFF	OFF	OFF	OFF	OFF	OFF	Stop charging and Discharge

3 Installation

3.1 tools

Tools			
Installation	Rubber mallet 	Cross Screwdriver 	Hammer drill (10 mm)
	ESD gloves 	Safety goggles 	Anti-dust respirator
	Safety shoes 		

3.2 Checking deliverables

After unpacking the battery, check whether deliverables are intact and complete, The below table shows the components and mechanical parts that should be delivered.

3.3 Installation requirement

- Install the battery in the in door environment.

- Place battery in secure location away from children and animals.
- Do not place the battery near any heat sources and avoid sparks.
- Do not expose the battery to moisture or liquids.
- Do not expose the battery to direct sunlight.
- Only mount battery on fire resistant building. Do not install batteries on flammable buildings.

3.4 Installation

Step 1

Placed the base against the wall, the distance between the base and the wall is 30mm as follows. Use the gradienter to keep the base is aclinic.

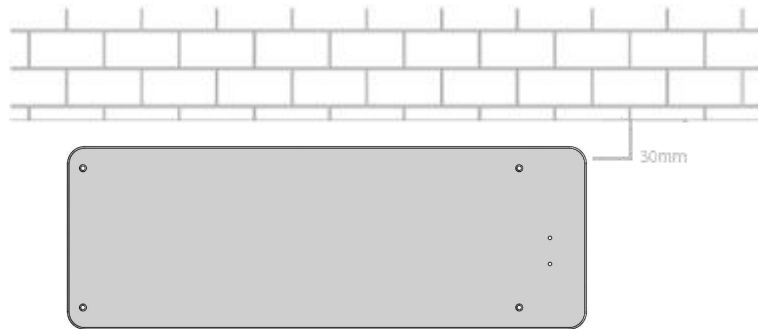

Step 2

Twist the dowel pin into the base and put the first battery pack on the base.

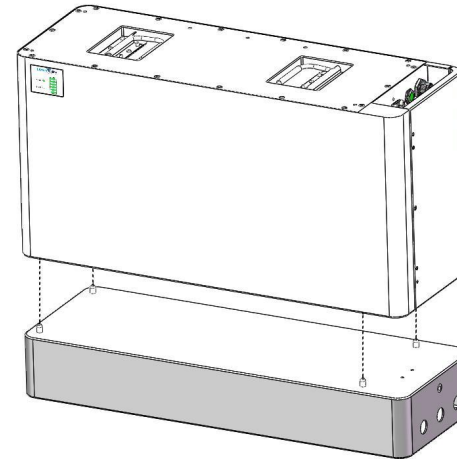

Step 3

Twist the dowel pin into the first battery pack.

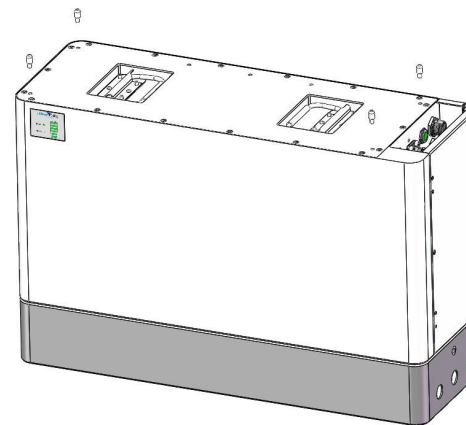

Step 4

Put the second battery pack onto the first pack.

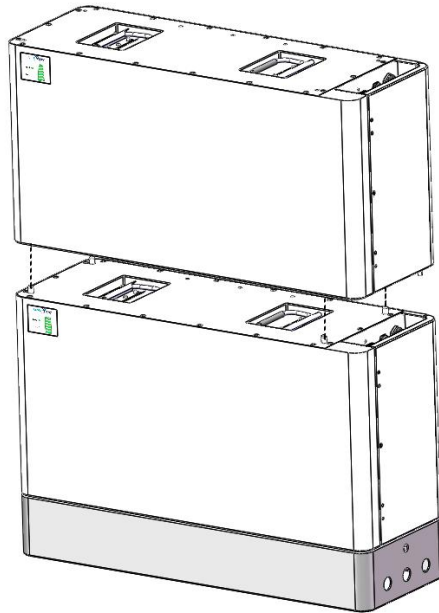

Step 5

As step3 and step4, put the third and fourth battery pack onto the second battery pack.

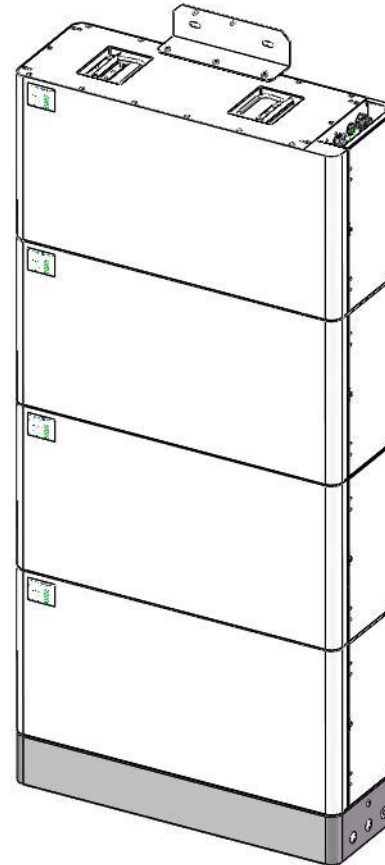

Step 6

Fixed the battery with the wall using a L shape metal parts and expansion bolts.

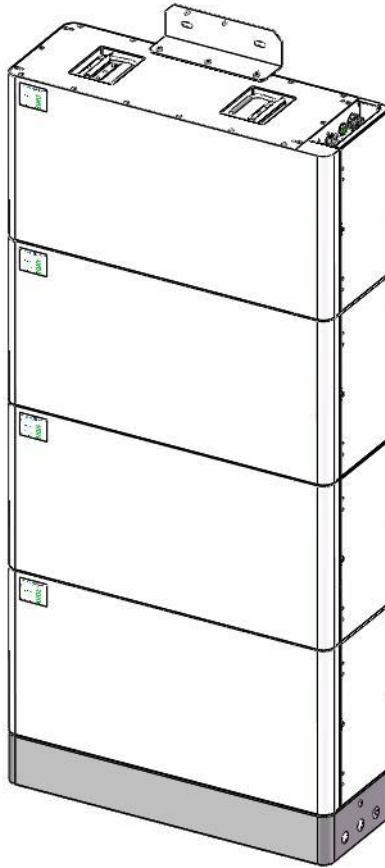

Step 7

Put the cover onto the battery pack and being fixed with battery pack using screw.

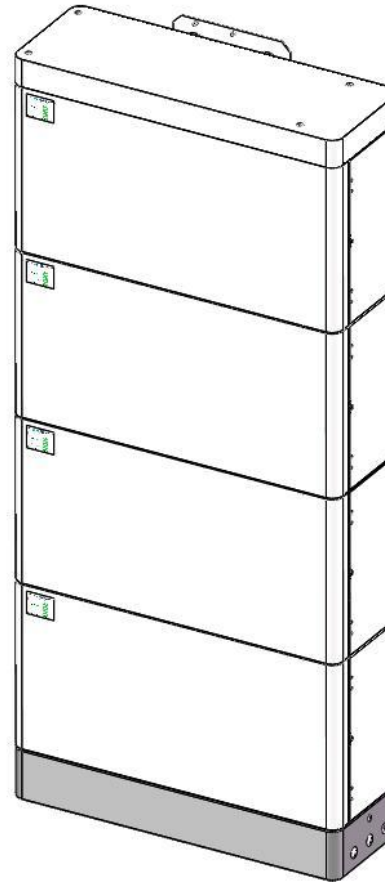

Step 8

Connect to ground with a small metal plate as follows.

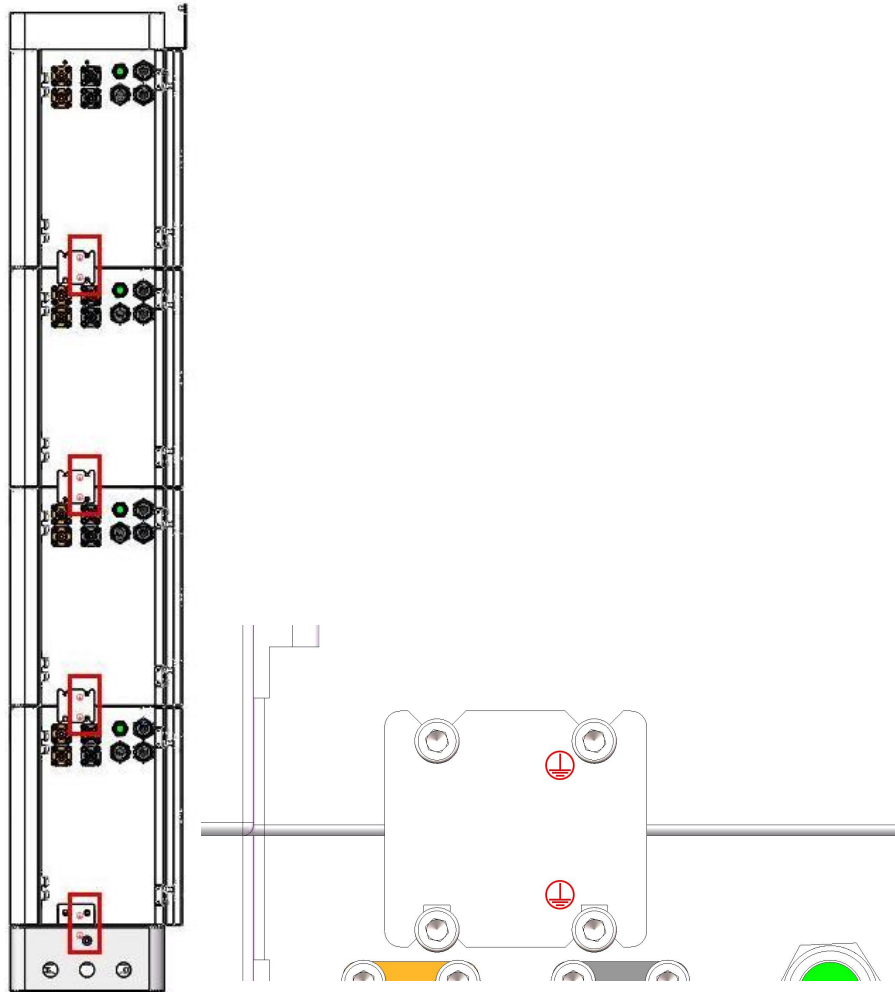

Step 9

Connect to the power and communication cable.

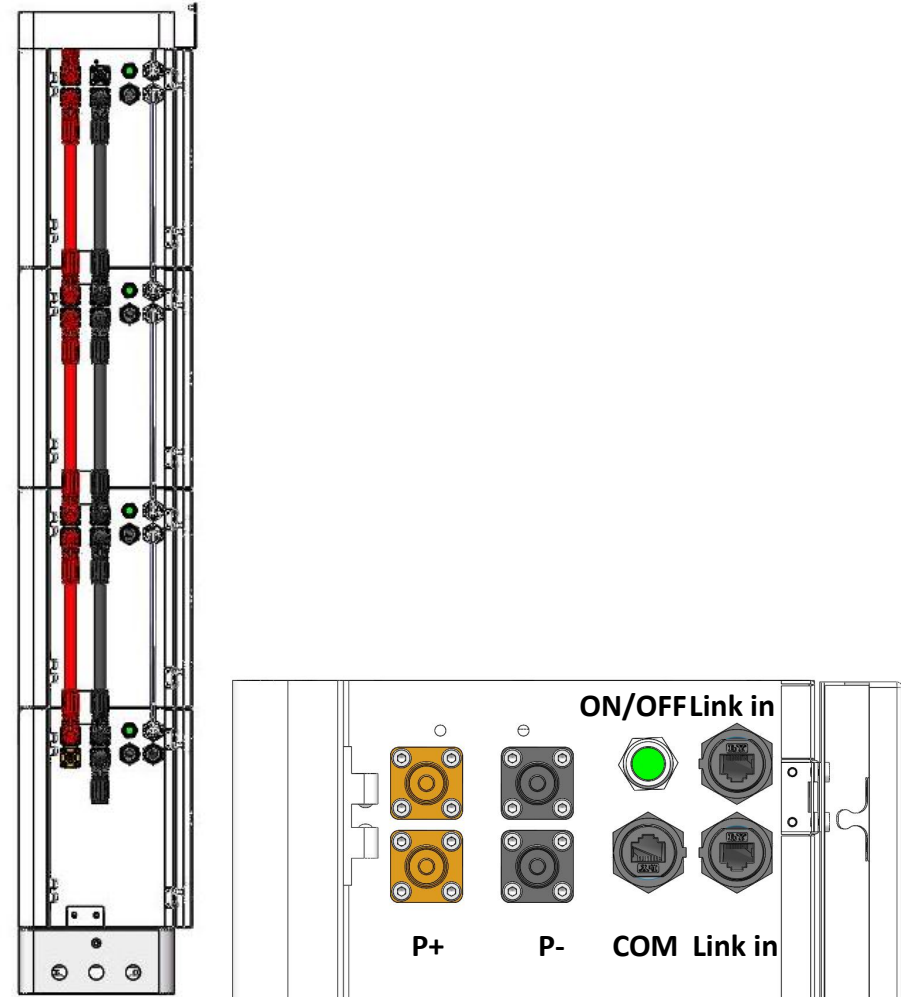

- Connect the first battery pack power Terminal+(BAT+)and the last battery pack power Terminal-(BAT-) to the inverter or the DC switches.
- The green cable is the communication for the batteries in parallel
- Connect the first battery pack COM Terminal to the inverter BMS port for communication between inverter and battery.

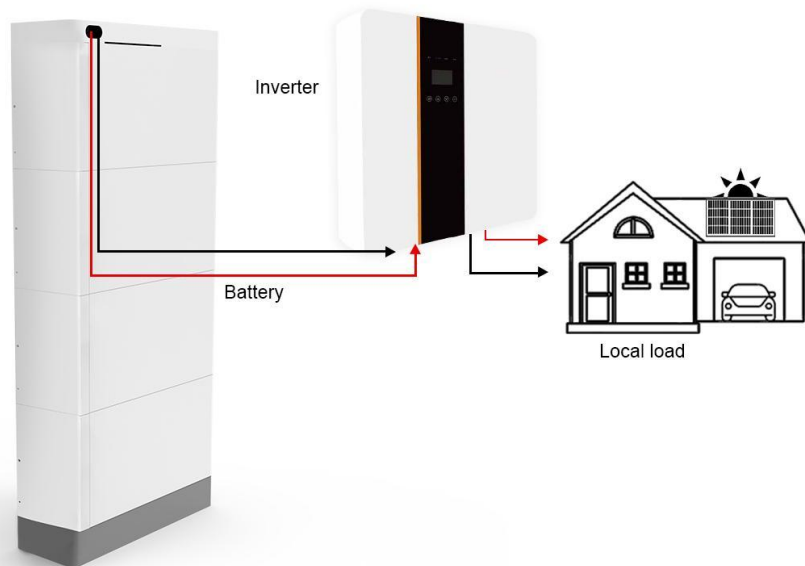

Danger: All the plugs and sockets of the power cables must be not reverse connection.

Danger: Do not short circuit or reserved connection of the battery system's positive and negative port.

Caution: Wrong communication cables connection will cause the battery system failure.

4 Maintenance

- Recharge Requirements During Normal Storage
Battery should be stored in an environment with temperature range between -10°C ~+45°C and maintained regularly according to following table with 0.5C(51A)current till40% SOC after long storagetime.

Storage Environment Temperature	Relative Humidity of Storage Environment	Storage Time	SOC
Below -10°C	/	prohibit	/
-10~25°C	5%~70%	≤12 months	30%≤SOC≤60%
25~35°C	5%~70%	≤6 months	30%≤SOC≤60%
35~45°C	5%~70%	≤3 months	30%≤SOC≤60%
Above 45°C	/	prohibit	/

- Recharge Requirements When Over Discharged

Over discharged (90% DOD) battery should be recharged according to following table, otherwise over discharged battery will be damaged.

Storage Environment Temperature	Storage Time	Note
-10~25°C	≤15 days	Battery Pack disconnected from PCS
25~35°C	≤7 days	
-10~45°C	<12 hours	Battery Pack connected to PCS